



DEPARTMENT OF REGULATORY AND ECONOMIC RESOURCES (RER)
BOARD AND CODE ADMINISTRATION DIVISION

MIAMI-DADE COUNTY
PRODUCT CONTROL SECTION
11805 SW 26 Street, Room 208
Miami, Florida 33175-2474
T (786) 315-2590 F (786) 315-2599

NOTICE OF ACCEPTANCE (NOA)

www.miamidade.gov/economy

Briscoe Shutters, Inc.
2841 Shoreview Drive
Naples, Florida 34112

SCOPE:

This NOA is being issued under the applicable rules and regulations governing the use of construction materials. The documentation submitted has been reviewed and accepted by Miami-Dade County RER- Product Control Section to be used in Miami Dade County and other areas where allowed by the Authority Having Jurisdiction (AHJ).

This NOA shall not be valid after the expiration date stated below. The Miami-Dade County Product Control Section (In Miami Dade County) and/or the AHJ (in areas other than Miami Dade County) reserve the right to have this product or material tested for quality assurance purposes. If this product or material fails to perform in the accepted manner, the manufacturer will incur the expense of such testing and the AHJ may immediately revoke, modify, or suspend the use of such product or material within their jurisdiction. RER reserves the right to revoke this acceptance, if it is determined by Miami-Dade County Product Control Section that this product or material fails to meet the requirements of the applicable building code.

This product is approved as described herein, and has been designed to comply with the High Velocity Hurricane Zone of the Florida Building Code.

DESCRIPTION: Aluminum Colonial Shutter

APPROVAL DOCUMENT: Drawing No. 13-0579, titled " Colonial Shutter System and Bahama over Colonial Shutter System ", sheets 1 through 10 of 10, prepared by Michael Trapasso, P.E., dated January 18, 2016, signed and sealed by Michael Trapasso, P.E., bearing the Miami-Dade County Product Control Revision stamp with the Notice of Acceptance number and the expiration date by the Miami-Dade County Product Control Section.

MISSILE IMPACT RATING: Large and Small Missile Impact Resistant

LABELING: Each unit shall bear a permanent label with the manufacturer's name or logo, city, state, the following statement: "Miami-Dade County Product Control Approved", and NOA number, per TAS-201, TAS-202, and TAS-203, unless otherwise noted herein.

RENEWAL of this NOA shall be considered after a renewal application has been filed and there has been no change in the applicable building code negatively affecting the performance of this product.

TERMINATION of this NOA will occur after the expiration date or if there has been a revision or change in the materials, use, and/or manufacture of the product or process. Misuse of this NOA as an endorsement of any product, for sales, advertising or any other purposes shall automatically terminate this NOA. Failure to comply with any section of this NOA shall be cause for termination and removal of NOA.

ADVERTISEMENT: The NOA number preceded by the words Miami-Dade County, Florida, and followed by the expiration date may be displayed in advertising literature. If any portion of the NOA is displayed, then it shall be done in its entirety.

INSPECTION: A copy of this entire NOA shall be provided to the user by the manufacturer or its distributors and shall be available for inspection at the job site at the request of the Building Official.

This NOA revises & renews NOA # 12-0927.01 and consists of this page 1, evidence submitted pages E-1, E-2, & E-3 as well as approval document mentioned above.

The submitted documentation was reviewed by **Helmy A. Makar, P.E., M.S.**



Helmy A. Makar
01/19/2017

NOA No. 16-0201.21
Expiration Date: 11/28/2022
Approval Date: 01/19/2017
Page 1

Briscoe Shutters, Inc.

NOTICE OF ACCEPTANCE: EVIDENCE SUBMITTED

1. EVIDENCE SUBMITTED UNDER PREVIOUS APPROVAL # 02-0722.04

A. DRAWINGS

1. *Drawing No. 13-0579 titled " Colonial Shutter Master Plan ", sheets 1 through 11 of 11, dated May 10, 2002, prepared by Arthur C. Quinnell, P.E, signed and sealed by Arthur C. Quinnell, P.E.*

B. TESTS

1. *Test report on Large Missile Impact Test, Cyclic Wind Pressure Test and Uniform Static Air Pressure Test of colonial shutters w/ four leaf assembly, prepared by Hurricane Test laboratory, Report No. 0288-0214.02, dated February 19-20, 2002, signed and sealed by Vinu J. Abraham, P.E.*
2. *Test report on Large Missile Impact Test, Cyclic Wind Pressure Test and Uniform Static Air Pressure Test of Double Bahama over Colonial Shutters w/ four leaf assembly, prepared by Hurricane Test laboratory, Report No. 0288-1218.01, dated December 13-14, 2001, signed and sealed by Vinu J. Abraham, P.E.*

C. CALCULATIONS

1. *Anchor analysis prepared by Briscoe shutter, Inc., signed and sealed by Arthur C. Quinnell, P.E.*

D. MATERIAL CERTIFICATIONS

1. *Mill Certified Inspection Report with chemical composition and mechanical properties for aluminum alloy 6063-T52.*

2. EVIDENCE SUBMITTED UNDER PREVIOUS APPROVAL #07-0713.05

A. DRAWINGS

1. *None.*

B. TEST

1. *None.*

C. CALCULATIONS

1. *None.*

D. QUALITY ASSURANCE

1. *By Miami-Dade County Building Code Compliance Office.*

E. MATERIAL CERTIFICATION

1. *None.*



Helmy A. Makar, P.E., M.S.
Product Control Section Supervisor
NOA No. 16-0201.21
Expiration Date: 11/28/2022
Approval Date: 01/19/2017

Briscoe Shutters, Inc.

NOTICE OF ACCEPTANCE: EVIDENCE SUBMITTED

3. EVIDENCE SUBMITTED UNDER PREVIOUS APPROVAL # 09-0122.08

A. DRAWINGS

1. *Drawing No. 13-0579, titled " Colonial Shutter System and Bahama over Colonial Shutter System ", sheets 1 through 11 of 11, prepared by Michael Trapasso, P.E., dated October 13, 2009, signed and sealed by Michael Trapasso, P.E.*

B. TESTS

1. *Test report on Large Missile Impact Test and Cyclic Wind Pressure Test of colonial shutters w/ four leaf assembly, prepared by Hurricane Test laboratory, Specimen #1B, Report No. 0288-0611.07, dated May 05, 2008, signed and sealed by Vinu J. Abraham, P.E.*
2. *Test report on Large Missile Impact Test and Cyclic Wind Pressure Test of colonial shutters w/ four leaf assembly, prepared by Hurricane Test laboratory, Specimen #4, Report No. 0288-0314.08, dated May 05, 2008, signed and sealed by Vinu J. Abraham, P.E.*
3. *Test report on Uniform Static Air Pressure Test of Bahama shutter System and Bahama over Colonial Shutter System, prepared by Hurricane Test laboratory, LLC Report No. 0288-0611-07, specimen #1, dated May 05, 2008, signed and sealed by Vinu J. Abraham, P.E.*

C. CALCULATIONS

1. *Anchor analysis prepared by Briscoe shutter, Inc., signed and sealed by Michael Trapasso, P.E.*

D. QUALITY ASSURANCE

1. *By Miami-Dade County Building Code Compliance Office.*

E. MATERIAL CERTIFICATIONS

1. *Mill Certified Inspection Report with chemical composition and mechanical properties for aluminum alloy 6063-T52.*

4. EVIDENCE SUBMITTED UNDER PREVIOUS APPROVAL # 12-0927.01

A. DRAWINGS

1. *Drawing No. 13-0579, titled " Colonial Shutter System and Bahama over Colonial Shutter System ", sheets 1 through 10 of 10, prepared by Michael Trapasso, P.E., dated September 01, 2012, signed and sealed by Michael Trapasso, P.E.*



Helmy A. Makar, P.E., M.S.
Product Control Section Supervisor

NOA No. 16-0201.21

Expiration Date: 11/28/2022

Approval Date: 01/19/2017

Briscoe Shutters, Inc.

NOTICE OF ACCEPTANCE: EVIDENCE SUBMITTED

B. TESTS

1. *None.*

C. CALCULATIONS

1. *Revision analysis prepared by Briscoe shutter, Inc., dated September 20, 2012, signed and sealed by Michael Trapasso, P.E.*

D. QUALITY ASSURANCE

1. *By Miami-Dade County Department of Regulatory and Economic Resources.*

E. MATERIAL CERTIFICATIONS

1. *None.*

5. NEW EVIDENCE SUBMITTED

A. DRAWINGS

1. *Drawing No. 13-0579, titled "Colonial Shutter System and Bahama over Colonial Shutter System", sheets 1 through 10 of 10, prepared by Michael Trapasso, P.E., dated January 18, 2016, signed and sealed by Michael Trapasso, P.E.*

B. TESTS

1. *None.*

C. CALCULATIONS

1. *None.*

D. QUALITY ASSURANCE

1. *By Miami-Dade County Department of Regulatory and Economic Resources.*

E. MATERIAL CERTIFICATIONS

1. *None.*

F. STATEMENTS

1. *Florida Building Code, 2014 Edition compliance letter, issued by Michael Trapasso, P.E., dated January 19, 2016, signed and sealed by Michael Trapasso, P.E.*



Helmy A. Makar, P.E., M.S.

Product Control Section Supervisor

NOA No. 16-0201.21

Expiration Date: 11/28/2022

Approval Date: 01/19/2017

COLONIAL SHUTTER SYSTEM and
BAHAMA over COLONIAL SHUTTER SYSTEM

MICHAEL TRAPASSO
PROFESSIONAL ENGINEER #62482

PRODUCT REVISED
as complying with the Florida
Building Code
Acceptance No. 16-0201-21
Expiration Date 11/28/2022
By: *Michael Trapasso*
Miami Dade Product Control

Maximum Design Pressures
Bahama & Colonial Shutters
+ 84.7 psf & -113.3 psf
Bahama Over Colonial Shutter
+ 77 psf & -77 psf

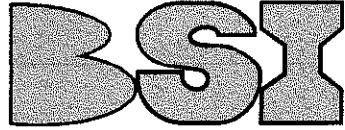

BRISCOE SHUTTERS INC.
2841 Shoreview Drive
Naples FL 34112
www.bsishutters.com
Office: 239-774-2025
Fax: 239-774-9483

Michael Trapasso
4/19/16
3609 COTTAGE CLUB LANE
NAPLES, FLORIDA 34105

DRAWING NO. 13-0579 SHEET NO. 1 of 10
DATE: 01/18/16

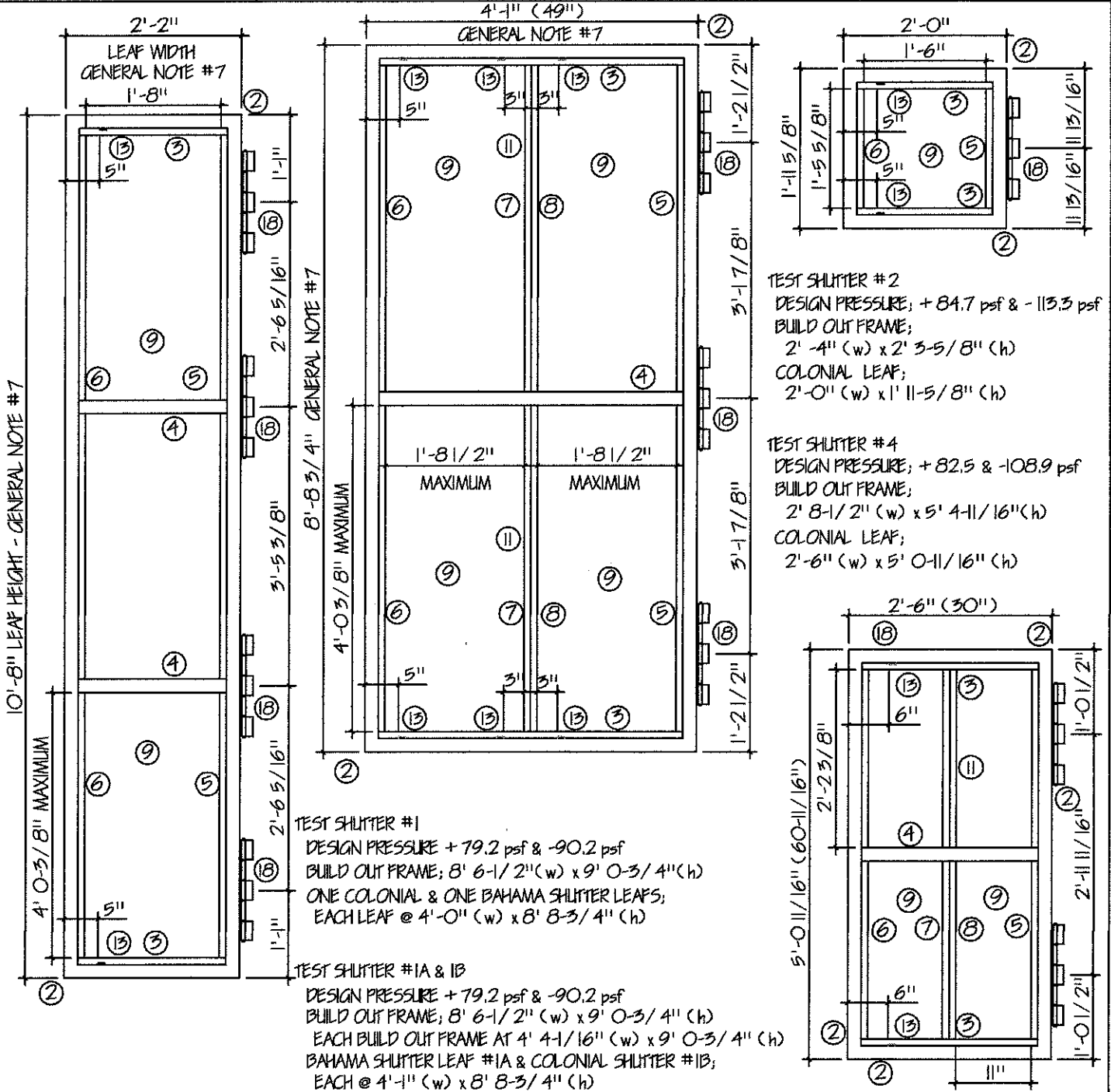

GENERAL NOTES SHEET 10: TEST STANDARDS, WIND SPEED CONVERSIONS, WIND LOADS - COMPONENTS & CLADDING,
ADJUSTMENT FACTOR FOR BUILDINGS HEIGHT & EXPOSURE, SHUTTER LEAF SIZES, FASTENER CALCULATIONS & LOCATIONS

COLONIAL SHUTTER SYSTEM and
BAHAMA over COLONIAL SHUTTER SYSTEM

MICHAEL TRAPASSO
PROFESSIONAL ENGINEER #62482

Maximum Design Pressures
Bahama & Colonial Shutters
+ 84.7 psf & -113.3 psf

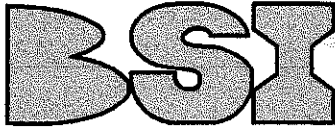

BRISCOE SHUTTERS INC.
2841 Shoreview Drive
Naples FL 34112
www.bsishutters.com
Office: 239-774-2025
Fax: 239-774-9485

Michael Trapasso
1/19/16
3609 COTTAGE CLUB LANE
NAPLES, FLORIDA 34105

PRODUCT REVISED
as complying with the Florida
Building Code
Acceptance No. 16-0201.21
Expiration Date 11/28/2022
By *Heidi...*
Miami Date Product Control

Bahama Over Colonial Shutter
+ 77 psf & -77 psf

Glass Separation Sheet 9

Patent No: US 6,996,934 B2
US 7,131,480 B2

DRAWING NO. 13-0579	SHEET NO. 2 of 10
DATE: 01/18/16	

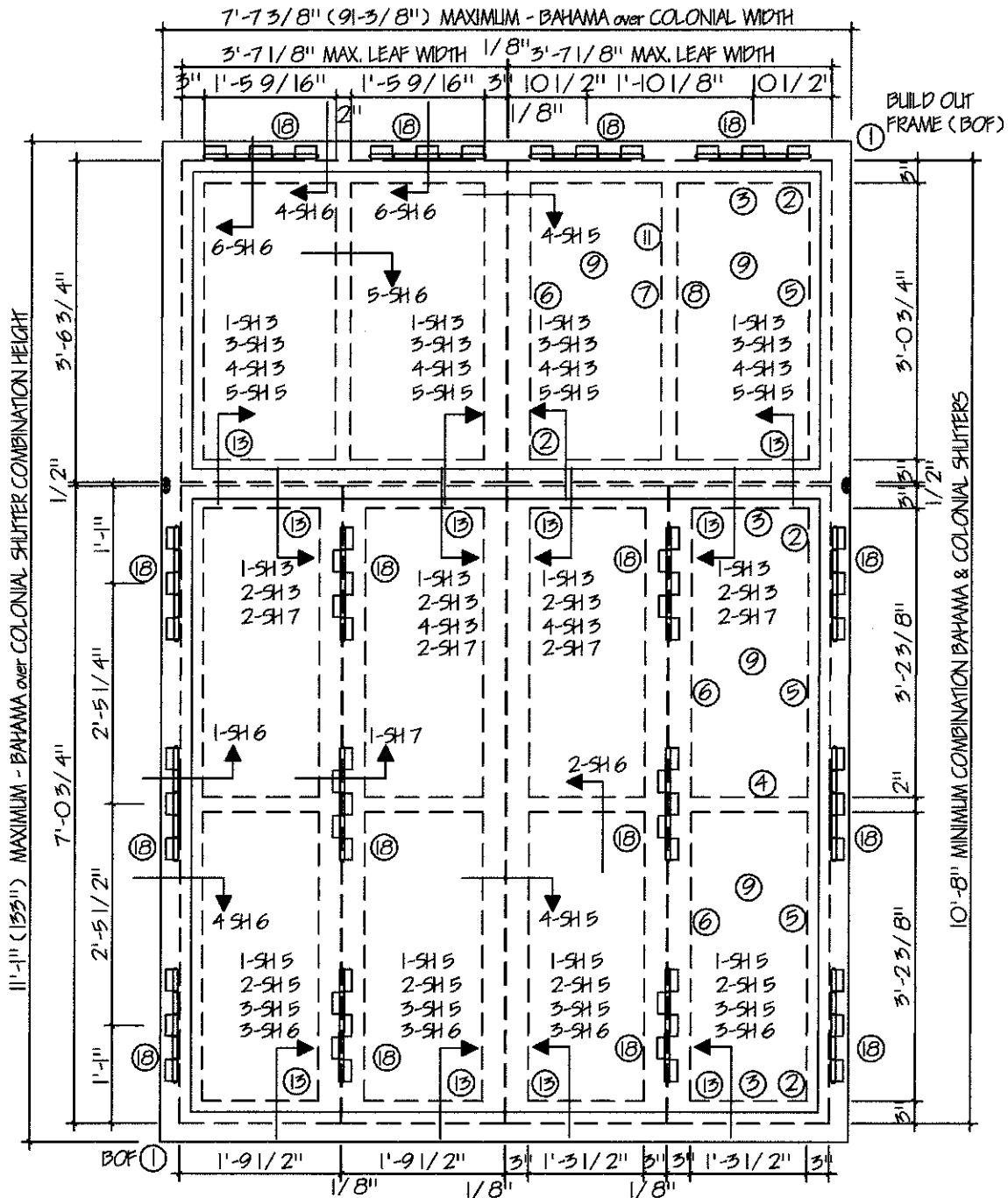

BAHAMA over COLONIAL SHUTTER SYSTEM - DESIGN PRESSURE: + 77 psf & -77 psf

GENERAL NOTES SHEET 10: TEST STANDARDS, WIND SPEED CONVERSIONS, WIND LOADS - COMPONENTS & CLADDING, ADJUSTMENT FACTOR FOR BUILDINGS HEIGHT & EXPOSURE, SHUTTER LEAF SIZES, FASTENER CALCULATIONS & LOCATIONS

COLONIAL SHUTTER SYSTEM and
BAHAMA over COLONIAL SHUTTER SYSTEM

MICHAEL TRAPASSO
PROFESSIONAL ENGINEER #62482

PRODUCT REVISED
as complying with the Florida
Building Code
Acceptance No. 16-0201.21
Expiration Date 11/28/2022
By: *Heb...*
Miami Data Product Control

Maximum Design Pressures
Bahama & Colonial Shutters
+ 84.7 psf & - 113.3 psf
Bahama Over Colonial Shutter
+ 77 psf & - 77 psf

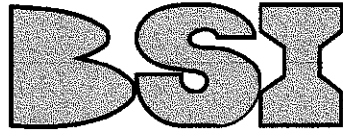

BRISCOE SHUTTERS INC.
2841 Shoreview Drive
Naples FL 34112
www.bsisshutters.com
Office: 239-774-2025
Fax: 239-774-9483

M. d. g.
1/19/16

3609 COTTON CLUB LANE
NAPLES, FLORIDA 34109

DRAWING NO. SHEET NO.
13-0579 3 of 10
DATE: 01/18/16

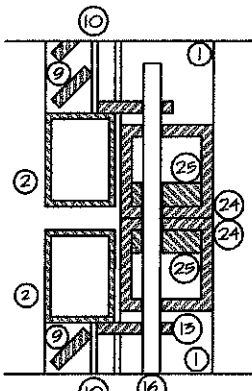
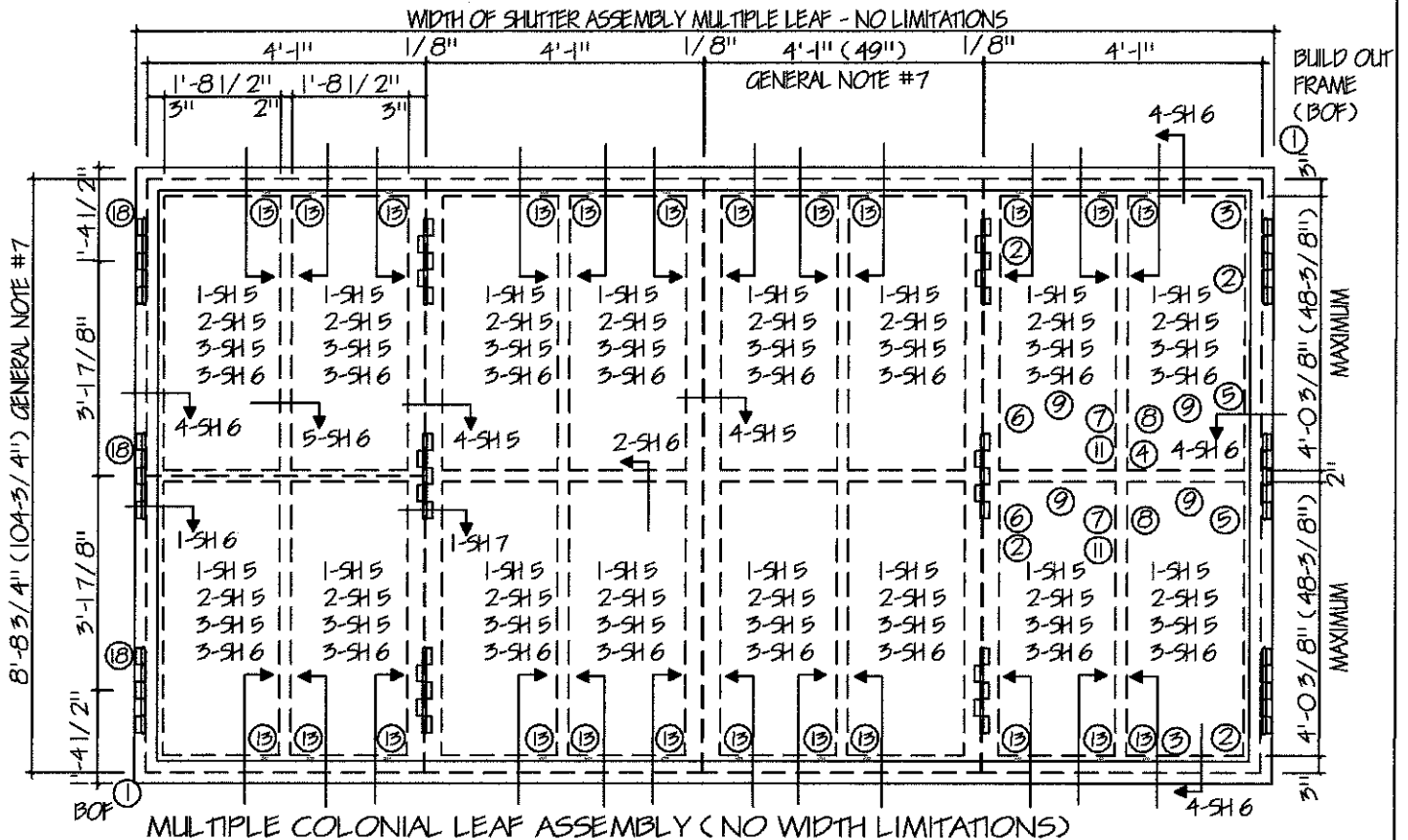

1 - SH 3
SECTION @ INSIDE CLOSURE
ROD @ HORIZONTAL MULLION
BAHAMA over COLONIAL

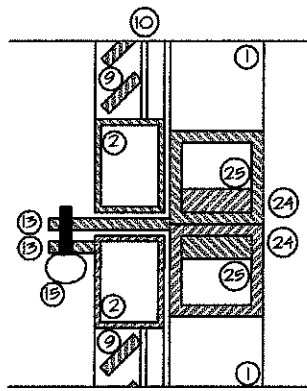

2 - SH 3
SECTION @ OUTSIDE CLOSURE
HORIZONTAL MULLION
BAHAMA over COLONIAL

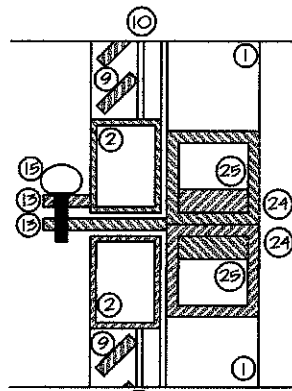

3 - SH 3
SECTION @ OUTSIDE CLOSURE
HORIZONTAL MULLION
BAHAMA over COLONIAL

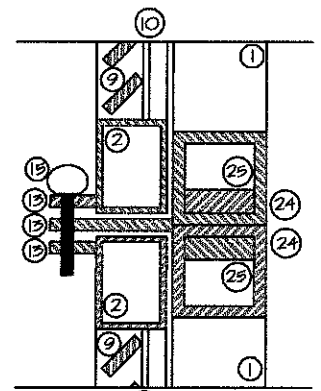

4 - SH 3
SECTION @ OUTSIDE CLOSURE
HORIZONTAL MULLION
BAHAMA over COLONIAL

GENERAL NOTES SHEET 10: TEST STANDARDS, WIND SPEED CONVERSIONS, WIND LOADS - COMPONENTS & CLADDING, ADJUSTMENT FACTOR FOR BUILDINGS HEIGHT & EXPOSURE, SHUTTER LEAF SIZES, FASTENER CALCULATIONS & LOCATIONS

**COLONIAL SHUTTER SYSTEM and
BAHAMA over COLONIAL SHUTTER SYSTEM**

MICHAEL TRAPASSO
PROFESSIONAL ENGINEER #62482

PRODUCT REVISED
as complying with the Florida
Building Code
Acceptance No 16-0201.21
Expiration Date 11/28/2022
By *Heather M...*
Miami Design Product Control

Maximum Design Pressures
Bahama & Colonial Shutters
+ 84.7 psf & - 113.3 psf
Bahama Over Colonial Shutter
+ 77 psf & - 77 psf

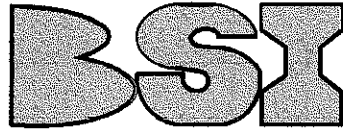

BRISCOE SHUTTERS INC.
2841 Shoreview Drive
Naples FL 34112
www.bsisshutters.com
Office: 239-774-2025
Fax: 239-774-9485

Michael Trapasso
1/19/16
3609 COTTAGE CLUB LANE
NAPLES, FLORIDA 34105

DRAWING NO. 13-0579	SHEET NO. 4 of 10
DATE: 01/18/16	

Glass Separation Sheet 9

Patent No: US 6,996,934 B2
US 7,131,480 B2

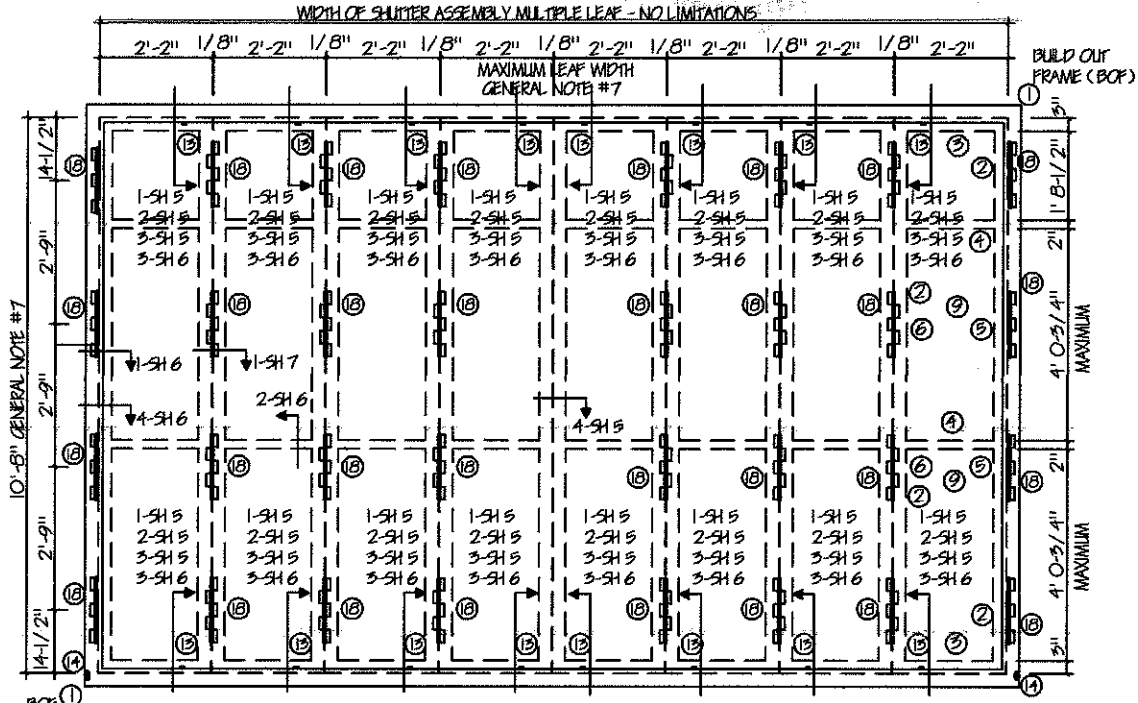

MULTIPLE COLONIAL LEAF ASSEMBLY (NO WIDTH LIMITATIONS)

HINGE ASSEMBLY

- 1 BAHAMA SHUTTER, 4'-1" (49") (w)
HINGES - 2 SETS OF 5 LEAF HINGES AT THE TOP PER SHUTTER, (3 LEAFS AT THE BUILD OUT FRAME & 2 LEAFS AT THE SHUTTER, WITH 3 SCREWS PER LEAF)
- 2 BAHAMA SHUTTER, 3'-7" (43") (w)
HINGES - 1 SET, 7 LEAF HINGE AT THE TOP PER SHUTTER, (4 LEAFS AT THE BUILD OUT FRAME & 3 LEAFS AT THE SHUTTER, WITH 3 SCREWS PER LEAF)
- 3 BAHAMA SHUTTER, 2'-6" (30") (w)
HINGES - 1 SET OF 5 LEAF HINGES AT THE TOP PER SHUTTER, (3 LEAFS AT THE BUILD OUT FRAME & 2 LEAFS AT THE SHUTTER, WITH 3 SCREWS PER LEAF)

HOLD CLOSE TABS

- 1 BAHAMA SHUTTER, 4'-1" (w) x 8' 8-3/4" (h) - 4 TABS, 2 @ 5" IN FROM OUTSIDE EDGE JAMBS & 2 @ 3" EACH SIDE OF CENTER LINE
- 2 BAHAMA SHUTTER, 3'-7" (w) x 6'-0" (h) - 2 TABS, 5" TO 6" IN FROM OUTSIDE EDGE JAMBS

SHUTTER LEAF TOLERANCES: ANY COMBINATION OF WIDTH x HEIGHT NOT TO EXCEED 35.64 SQ FT PER LEAF IS ALLOWED WITHIN THE DESIGN PRESSURE

BAHAMA SHUTTER SYSTEM ASSEMBLY:

BAHAMA LEAF; WIDTH 4'-1" (49"), HEIGHT 8' 8-3/4" (103-3/4"), GENERAL NOTE #7

BAHAMA over COLONIAL SHUTTER SYSTEM ASSEMBLY:

COMBINED BAHAMA & COLONIAL; BOF WIDTH 7' 7-3/8" (91-3/8"), HEIGHT 11'-1" (133") GENERAL NOTE #7

MAXIMUM BAHAMA LEAF; WIDTH 3' 7-1/8" (43-1/8"), MAXIMUM COMBINED HEIGHT - BAHAMA HEIGHT PLUS COLONIAL HEIGHT NOT TO EXCEED 10'-8" (128"), GENERAL NOTE #7

MAXIMUM COLONIAL LEAF; WIDTH 1' 9-1/2" (21-1/2"), MAXIMUM COMBINED HEIGHT - BAHAMA HEIGHT PLUS COLONIAL HEIGHT NOT TO EXCEED 10'-8" (128"), GENERAL NOTE #7

COLONIAL SHUTTER SYSTEM ASSEMBLY:

COLONIAL LEAF; WIDTH 2'-2" (26"), HEIGHT 10'-8" (128"), GENERAL NOTE #7

COLONIAL LEAF; WIDTH 4'-1" (49"), HEIGHT 8' 8-3/4" (103-3/4"), GENERAL NOTE #7

GENERAL NOTES SHEET 10: TEST STANDARDS, WIND SPEED CONVERSIONS, WIND LOADS - COMPONENTS & CLADDING, ADJUSTMENT FACTOR FOR BUILDINGS HEIGHT & EXPOSURE, SHUTTER LEAF SIZES, FASTENER CALCULATIONS & LOCATIONS

COLONIAL SHUTTER SYSTEM and
BAHAMA over COLONIAL SHUTTER SYSTEM

MICHAEL TRAPASSO
PROFESSIONAL ENGINEER #62482

PRODUCT REVISED
as complying with the Florida
Building Code
Acceptance No 16-0201.21
Expiration Date 11/28/2022
By *Heidi A. [Signature]*
Miami Dade Product Control

Maximum Design Pressures
Bahama & Colonial Shutters
+ 84.7 psf & - 113.3 psf
Bahama Over Colonial Shutter
+ 77 psf & - 77 psf

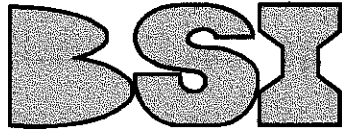

BRISCOE SHUTTERS INC.
2841 Shoreview Drive
Naples FL 34112
www.bsisshutters.com
Office: 239-774-2025
Fax: 239-774-9483

Michael Trapasso
1/19/16
3609 COTTAGE CLUB LANE
NAPLES, FLORIDA 34105

DRAWING NO. 13-0579 SHEET NO. 5 of 10
DATE: 01/18/16

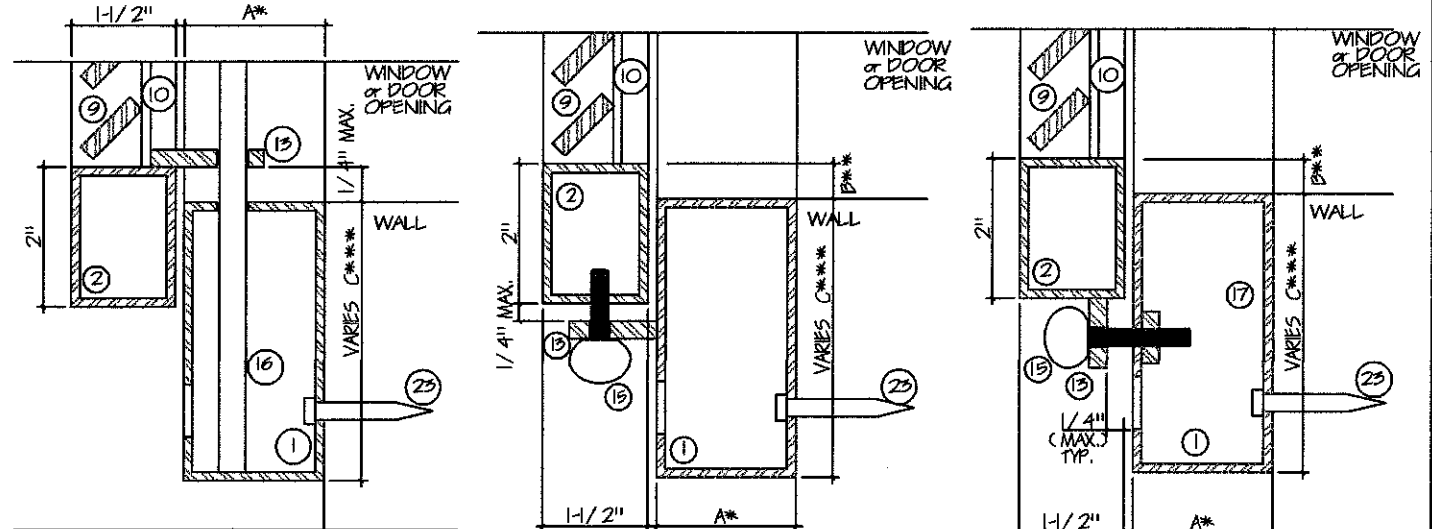

1-SH 5 SECTION: INSIDE CLOSURE ROD @ SILL or HEAD

2-SH 5 SECTION: SILL or HEAD OUTSIDE CLOSURE - VERTICAL THUMBSCREW

3-SH 5 SECTION: SILL or HEAD OUTSIDE CLOSURE HORIZONTAL - THUMBSCREW

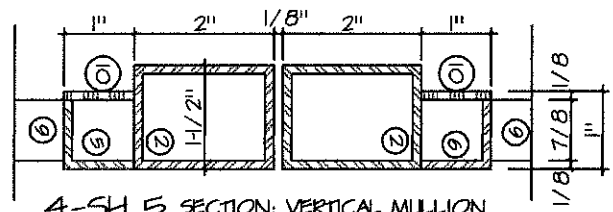

4-SH 5 SECTION: VERTICAL MULLION

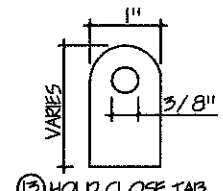

13 HOLD CLOSE TAB

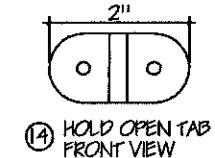

14 HOLD OPEN TAB FRONT VIEW

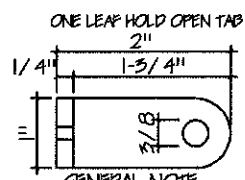

15 ONE LEAF HOLD OPEN TAB SIDE VIEW

14 HOLD OPEN TAB SIDE VIEW

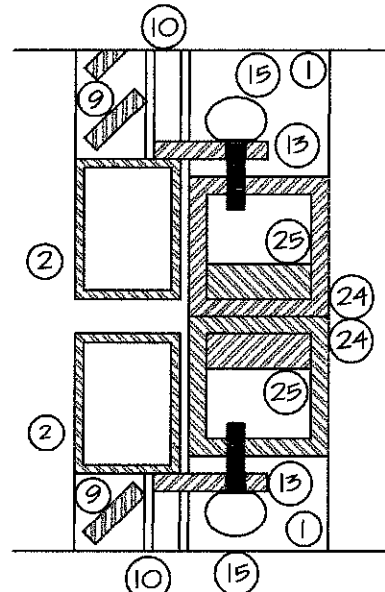

5-SH 5 SECTION: INSIDE CLOSURE THUMBSCREWS @ HORIZONTAL MULLION

NOTES:

- A* DEPTH OF BUILD OUT FRAME ① - REFER TO SHEET 9 "MINIMUM GLASS SEPARATION"
- B*** DIMENSION VARIES: SLAT SPACING TO ACCOMMODATE FULL SLAT (1/4" x 1" FLAT BAR @ 45 DEGREE) IN SLAT WELD GUIDES ⑤ & ⑥
- C*** WIDTH VARIES MINIMUM 3"

GENERAL NOTES SHEET 10: TEST STANDARDS, WIND LOADS CONVERSIONS, WIND LOADS - COMPONENTS & CLADDING, ADJUSTMENT FACTOR FOR BUILDINGS HEIGHT & EXPOSURE, SHUTTER LEAF SIZES, FASTENER CALCULATIONS & LOCATIONS

COLONIAL SHUTTER SYSTEM and
BAHAMA over COLONIAL SHUTTER SYSTEM

MICHAEL TRAPASSO
PROFESSIONAL ENGINEER #62482

PRODUCT REVISED
as complying with the Florida
Building Code
Acceptance No 16-0201.21
Expiration Date 11/28/2022
By *Helga Miller*
Miami Dade Product Control

Maximum Design Pressures
Bahama & Colonial Shutters
+ 84.7 psf & -113.3 psf
Bahama Over Colonial Shutter
+ 77 psf & -77 psf

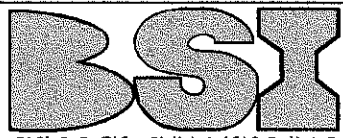

BRISCOE SHUTTERS INC.
2841 Shoreview Drive
Naples FL 34112
www.bsishutters.com
Office: 239-774-2025
Fax: 239-774-9485

Michael Trapasso
1/19/16
3609 COTTAGE CLUB LANE
NAPLES, FLORIDA 34105

Glass Separation Sheet 9

Patent No: US 6,996,934 B2
US 7,131,480 B2

DRAWING NO. 13-0579	SHEET NO. 6 of 10
DATE: 01/18/16	

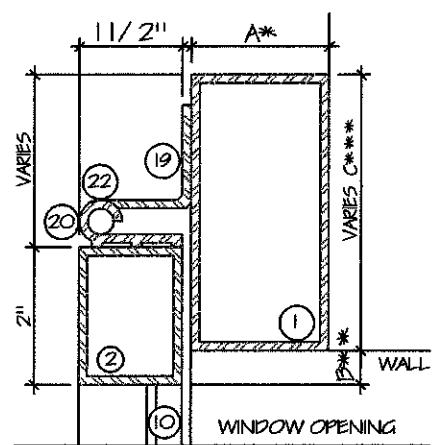

1-SH 6 SECTION @ HINGE HEAD or JAMB

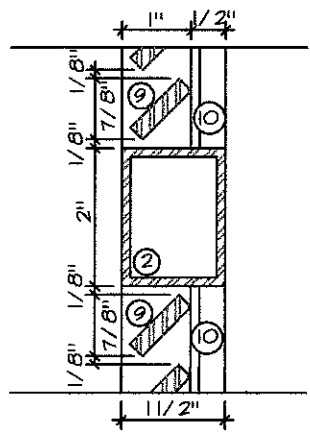

2-SH 6 SECTION @ HORIZONTAL MULLION FRAME

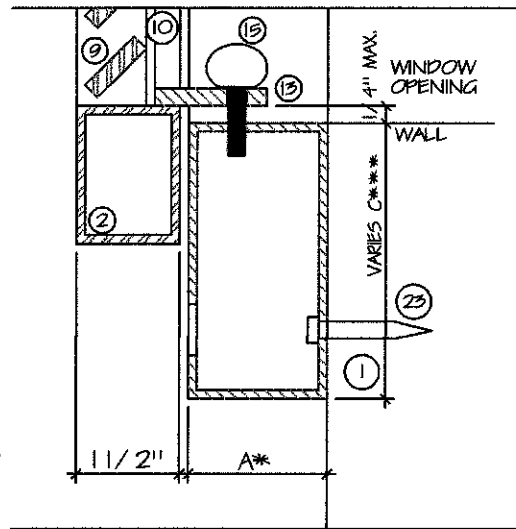

3-SH 6 SECTION @ SILL or HEAD INSIDE CLOSURE THUMBSCREW

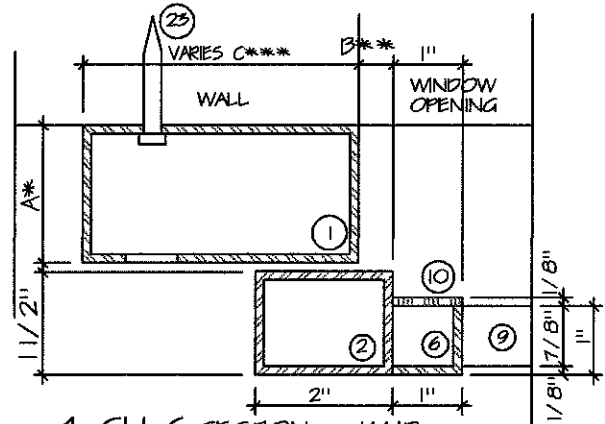

4-SH 6 SECTION @ JAMB

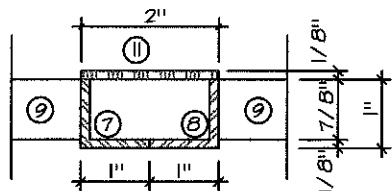

5-SH 6 SECTION @ VERTICAL CENTER MULLION

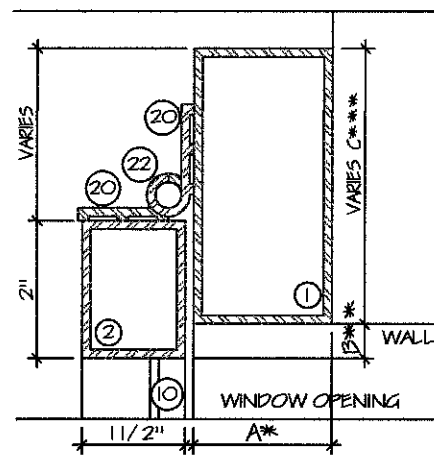

6-SH 6 SECTION @ HINGE HEAD or JAMB

NOTES:

- A* DEPTH OF BUILD OUT FRAME ① = REFER TO SHEET 9 "MINIMUM GLASS SEPARATION"
- B*** DIMENSION VARIES; SLAT SPACING TO ACCOMMODATE FULL SLAT (1/4 x 1 Flat Bar @ 45-Degree) IN SLAT WELD GUIDES ⑤ & ⑥
- C*** WIDTH VARIES MINIMUM 3"

GENERAL NOTES SHEET 10: TEST STANDARDS, WIND SPEED CONVERSIONS, WIND LOADS - COMPONENTS & CLADDING, ADJUSTMENT FACTOR FOR BUILDINGS HEIGHT & EXPOSURE, SHUTTER LEAF SIZES, FASTENER SCHEDULES & LOCATIONS

COLONIAL SHUTTER SYSTEM and
BAHAMA over COLONIAL SHUTTER SYSTEM

MICHAEL TRAPASSO
PROFESSIONAL ENGINEER #62482

Maximum Design Pressures
Bahama & Colonial Shutters
+ 84.7 psf & - 113.3 psf

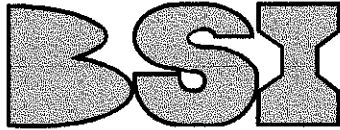

BRISCOE SHUTTERS INC.
2841 Shoreview Drive
Naples FL 34112
www.bsishutters.com
Office: 239-774-2025
Fax: 239-774-9483

M. Trapasso
1/19/16
3609 COTTAGE CLUB LANE
NAPLES, FLORIDA 34105

PRODUCT REVISED
as complying with the Florida
Building Code
Acceptance No 16-0201-21
Expiration Date 11/28/2022
By *H. G. Miller*
Miami Data Product Control

Class Separation Sheet 9
Patent No: US 6,996,934 B2
US 7,131,480 B2

DRAWING NO. 13-0579
SHEET NO. 7 of 10
DATE: 01/18/16

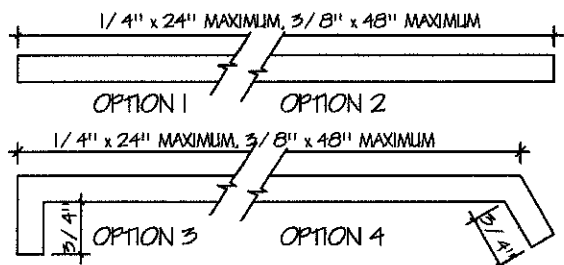
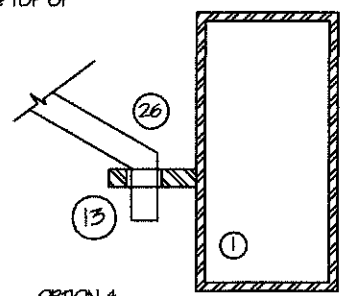
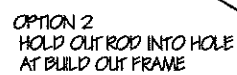
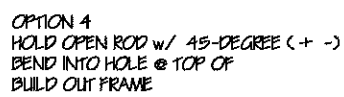
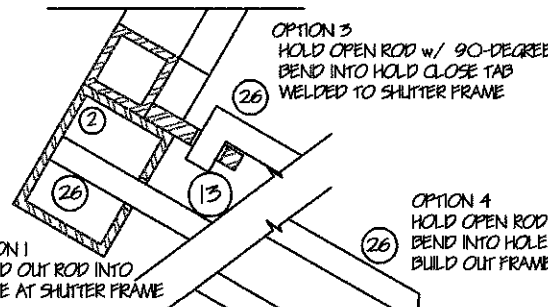
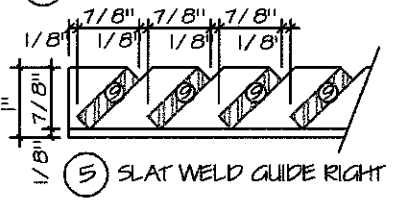
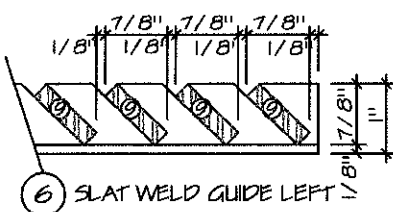
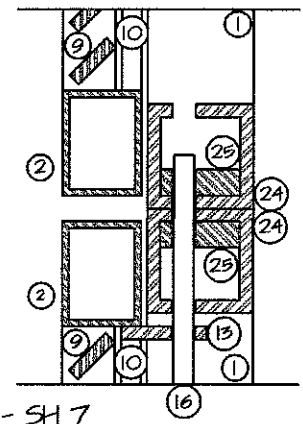
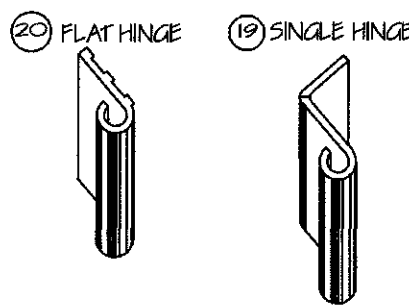
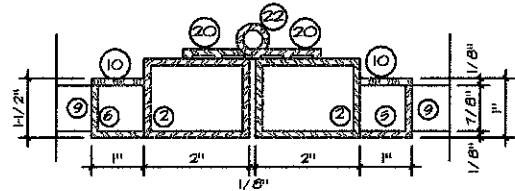
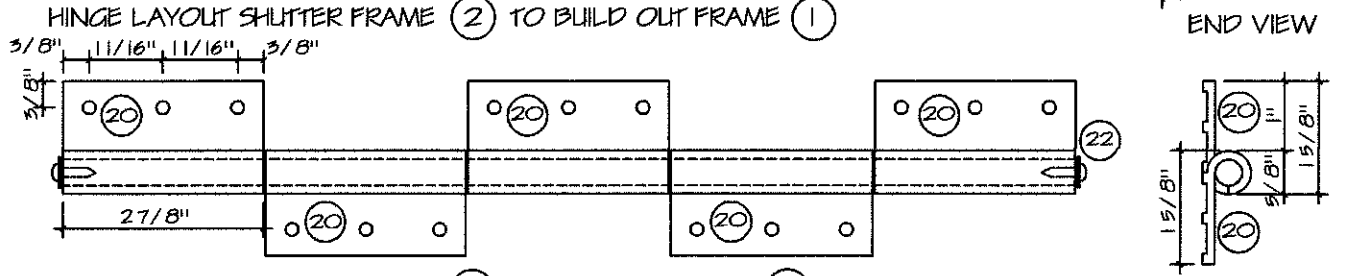
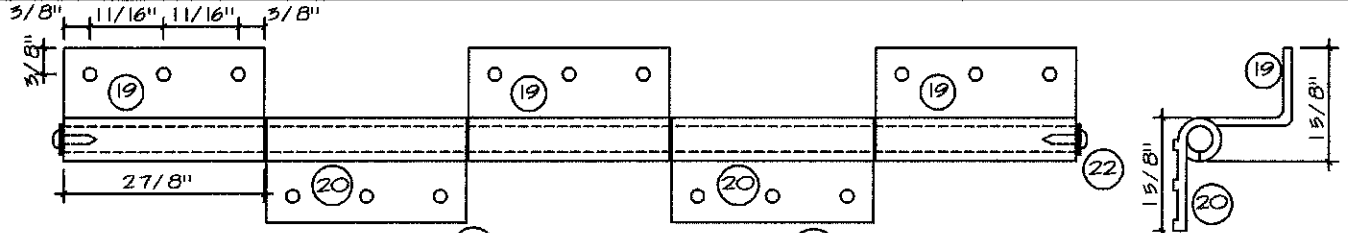

26 BAHAMA HOLD OPEN ROD

SECTION @ BAHAMA HOLD OPEN ROD LOCATIONS

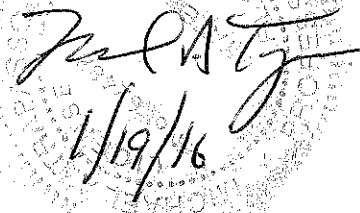
COLONIAL SHUTTER SYSTEM and BAHAMA over COLONIAL SHUTTER SYSTEM		MICHAEL TRAPASSO PROFESSIONAL ENGINEER #62482	PRODUCT REVISED as complying with the Florida Building Code Acceptance No. <u>16-020121</u> Expiration Date <u>11/28/2022</u> By <u>Heidi M. ...</u> Manual Design Product Control				
Maximum Design Pressures Bahama & Colonial Shutters + 84.7 psf & - 113.3 psf Bahama Over Colonial Shutter + 77 psf & - 77 psf	 BRISCOE SHUTTERS INC. 2841 Shoreview Drive Naples FL 34112 www.bsishutters.com Office: 239-774-2025 Fax: 239-774-9485	 <u>1/19/16</u> 3609 COTTAGE CLUB LANE NAPLES, FLORIDA 34105					
Class Separation Sheet 9 Patent No: US 6,996,934 B2 US 7,131,480 B2		<table border="1" style="width:100%; border-collapse: collapse;"> <tr> <td style="width: 50%;">DRAWING NO. 13-0579</td> <td style="width: 50%;">SHEET NO. 8 of 10</td> </tr> <tr> <td colspan="2">DATE: 01/18/16</td> </tr> </table>		DRAWING NO. 13-0579	SHEET NO. 8 of 10	DATE: 01/18/16	
DRAWING NO. 13-0579	SHEET NO. 8 of 10						
DATE: 01/18/16							

DESCRIPTION OF MATERIAL

Item#	DESCRIPTION OF MATERIAL	SIZE	TYPE	MATERIAL GRADE
1	BUILD OUT FRAME	A* x C*** x 1/8"	TUBE	ALUMINUM 6063-T52
2	SHUTTER FRAME	1 1/2" x 2" x 1/8"	TUBE	ALUMINUM 6063-T52
3	SPACER	1" x 1" x 1/8"	TUBE	ALUMINUM 6063-T52
4	HORIZONTAL MULLION	1 1/2" x 2" x 1/8"	TUBE	ALUMINUM 6063-T52
5	SLAT WELD GUIDE RIGHT	1" x 1" x 1/8"	ANGLE	ALUMINUM 6063-T52
6	SLAT WELD GUIDE LEFT	1" x 1" x 1/8"	ANGLE	ALUMINUM 6063-T52
7	VERTICAL MULLION RIGHT	1" x 1" x 1/8"	ANGLE	ALUMINUM 6063-T52
8	VERTICAL MULLION LEFT	1" x 1" x 1/8"	ANGLE	ALUMINUM 6063-T52
9	SLATS	1/4" x 1"	FLAT BAR	ALUMINUM 6063-T52
10	JAMB WELD GUIDE COVER	1" x 1/8"	FLAT BAR	ALUMINUM 6063-T52
11	VERTICAL MULLION BACK COVER	1/8" x 2"	FLAT BAR	ALUMINUM 6063-T52
12				
13	HOLD CLOSE TAB	1/4" x 1" x Varies	FLAT BAR	ALUMINUM 6063-T52
14	HOLD OPEN TAB	1/4" x 1" x Varies	FLAT BAR	ALUMINUM 6063-T52
15-15*	SHUTTER CLOSURE THUMBSCREW	1/4" x 1" or *1 1/2"	THUMBSCREW	STAINLESS STEEL
16	INSIDE CLOSURE ROD	3/8" x VARIES PER SHUTTER	ROD	ALUMINUM 6063-T52
17				
18	HINGE ASSEMBLY			
19	SINGLE HINGE	3/16" x 2-7/8" x 1-5/8"		ALUMINUM 6061-T6
20	FLAT HINGE	3/16" x 2-7/8" x 1-5/8"		ALUMINUM 6061-T6
21	HINGE SCREWS	#10 x 1" 3 AT EACH HINGE LEAF		HEX SELF-DRILLING
22	HINGE PIN	3/8" DIAMETER	ROD	ALUMINUM 6063-T52
23	BUILD OUT FRAME FASTENERS			
	CONCRETE BLOCK HOLLOW	1/4" x MIN EMBED 1 1/4"	S.S. CONC. SCREW	ELCO IND. or EQUAL
	CONCRETE BLOCK; CONC. FILL	1/4" x MIN EMBED 1 1/4"	S.S. CONC. SCREW	ELCO IND. or EQUAL
	WOOD FRAMING	1/4" x MIN. EMBED 1 1/4"	LAG BOLT or SS CONC. SCREW	ELCO IND. or EQUAL
	WOOD FRAMING	5/16" x MIN. EMBED 1 1/4"	LAG BOLT or SS CONC. SCREW	ZINC, SS or EQUAL
	METAL FRAMING	12-24 x MIN. EMBED 1"	TEK SCREW	TEK SELF-DRILLING
24	HORIZONTAL MULLION	2" x 2" x 1/4"	TUBE	ALUMINUM 6061-T6
25	HORIZONTAL MULLION STIFFENER	1/2" x 1-1/2"	FLAT BAR	ALUMINUM 6061-T6
26	HOLD OUT ROD	1/4 x 24" MAXIMUM, 3/8" X 48" MAXIMUM	ROD	ALUMINUM 6063-T52

ASSEMBLY METHOD:

SHUTTER FRAME

- 1A SHUTTER FRAME CORNER CONSTRUCTION, AT EACH PANEL CORNER, THE ADJOINING STILE / RAIL ENDS ARE MITER CUT, BUTTED AND WELDED TOGETHER USING TWO (2) 1/4" x 2-13/16" FILET WELDS - ONE PER FACE, EACH FACE WELD IS GROUND DOWN SMOOTH
- 1B INTERMEDIATE RAIL END CONSTRUCTION, AT EACH INTERMEDIATE RAIL END, THE RAIL IS SQUARE CUT, BUTTED AND WELDED TO THE ADJACENT PANEL FRAME MEMBER USING TWO (2) 1/4" x 2" FILET WELDS - ONE PER FACE, EACH FACE WELD IS GROUND SMOOTH
- 1C SLAT WELD GUIDES WELDED TO THE SHUTTER FRAME JAMBS ON THE INSIDE AT 6" O/C, TOP AND BOTTOM
- 1D VERTICAL MULLION WELD GUIDE; ONE RIGHT WELD GUIDE AND ONE LEFT WELD GUIDE WELDED TOGETHER ON THE INSIDE AT 6" O/C, THIS MEMBER IS WELDED TO THE HEAD, MULLIONS, AND SILL
- 1E SLANTED SLAT CONSTRUCTION, ALL SLATS ARE SQUARE CUT AND WELDED AT EACH END TO THE ADJACENT PANEL STILE MEMBER USING ONE (1) 1/4" x 1" FILET WELD

BUILD OUT FRAME

- 2A BUILD OUT FRAME CONSTRUCTION, AT EACH CORNER THE ADJOINING STILE / RAIL ENDS ARE MITER CUT, BUTTED AND WELDED TOGETHER USING TWO (2) 1/4" x 4-1/4" (1 x 3) OR TWO (2) 1/4" x 5 11/16" (1 x 4) FILER WELDS - ONE PER FACE. EACH FACE WELD IS GROUND DOWN SMOOTH

COLONIAL SHUTTER SYSTEM and
BAHAMA over COLONIAL SHUTTER SYSTEM

Maximum Design Pressures
Bahama & Colonial Shutters
+ 84.7 psf & -113.3 psf
Bahama Over Colonial Shutter
+ 77 psf & -77 psf

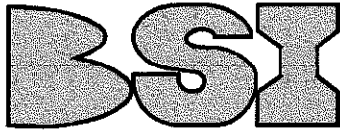

BRISCOE SHUTTERS INC.
2841 Shoreview Drive
Naples Fl 34112
www.bsishutters.com
Office: 239-774-2025
Fax: 239-774-9483

Glass Separation Sheet 9

Patent No: US 6,996,934 B2
US 7,131,480 B2

MICHAEL TRAPASSO
PROFESSIONAL ENGINEER #62482



3609 COTTAGE CLUB LANE
NAPLES, FLORIDA 34105

PRODUCT REVISED
as complying with the Florida
Building Code
Acceptance No 16-0201.21
Expiration Date 11/28/2022
By *Hebert, Mark*
Miami Date Product Control

DRAWING NO. 13-0579 SHEET NO. 9 of 10
DATE: 01/18/16

EXAMPLE

A 41.6 sq. ft. shutter has a
negative 101.75 psf
design pressure.

41.6 sq. ft. x 101.75 psf
= 4,252.8 lb. design load.

BSI HURRICANE SHUTTER SYSTEMS HAS A BUILD OUT FRAME (BOF) ①
THAT ATTACHES TO THE BUILDING (INSIDE CLEAR OPENING IS 1/4"
LARGER THEN BUILDING OPENING). DEPTH OF BOF IS GOVERNED
BY THE GLASS SEPARATION, SHUTTERS ARE FACTORY ASSEMBLED
TO THE BOF THEN DISASSEMBLED FOR SHIPPING & INSTALLATION

BUILD OUT FRAME DEPTH IS GOVERNED BY THE GLASS SEPARATION
FURTHEST OUTWARD GLASS SURFACE TO BACK OF SHUTTER SLATS

DISTANCE FROM FACE OF BUILDING TO FURTHEST OUTWARD GLASS
SURFACE, MINUS (-) MINIMUM GLASS SEPARATION = DEPTH OF
BUILD OUT FRAME (MINIMUM DEPTH !!!)

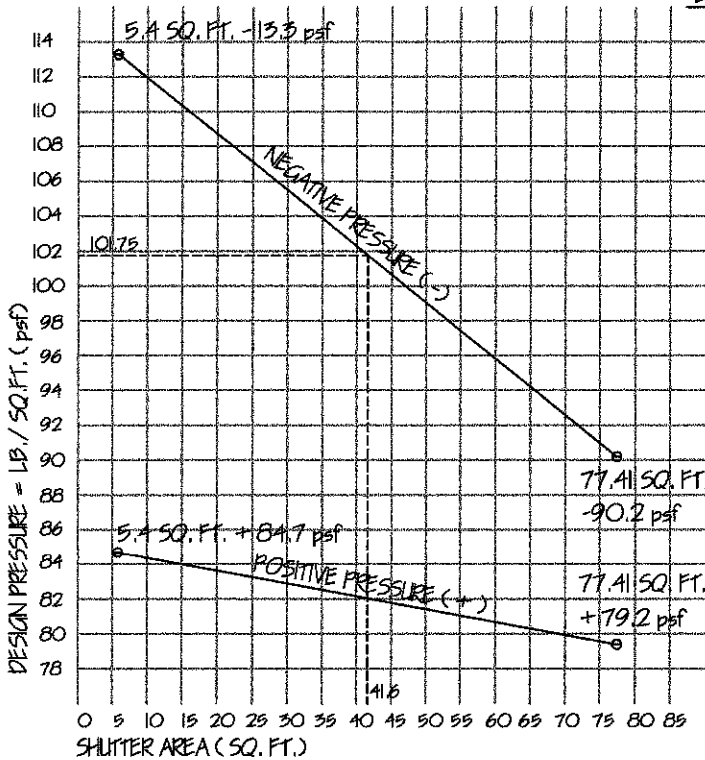

DESIGN PRESSURE CHART FOR FASTENER LOAD
CALCULATIONS BAHAMA & COLONIAL SHUTTER SYSTEMS

MINIMUM GLASS SEPARATION BACK OF SLATS TO GLASS			
SHUTTER SIZE	MAX. SQ. FT.	TYPE OF SHUTTER	SEPARATION
24" x 23.625" to 30" x 60.6875"	3.94 sq ft to 12.64 sq ft	BAHAMA or COLONIAL	2-1/4"
30.01" x 60.7 to 49" x 104.75" & 26" x 128"	12.65 sq ft to 35.64 sq ft & 21.11 sq ft	BAHAMA or COLONIAL	2-3/4"
ALL SIZES	84.4 sq ft	BAHAMA over COLONIAL	3-1/4"

ANY COMBINATION OF WIDTH x HEIGHT NOT TO EXCEED 35.64 sq ft
PER LEAF IS ALLOWABLE WITHIN THE DESIGN PRESSURE, GENERAL
NOTE #7, SHEET 10

EXAMPLE

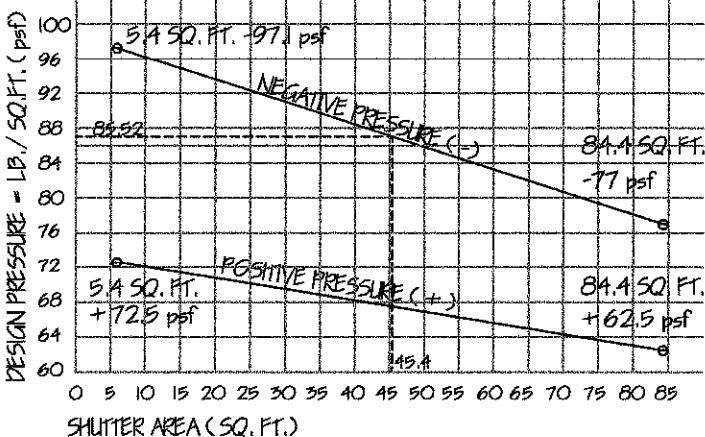

A 45.4 sq. ft. shutter has a
negative 85.2 psf
design pressure.

45.4 sq. ft. x 85.2 psf
= 3,868.08 lb. design load.

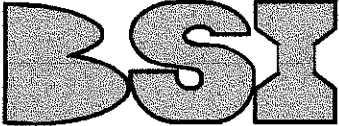

DESIGN PRESSURE CHART FOR FASTENER LOAD
CALCULATIONS BAHAMA over COLONIAL SHUTTER SYSTEM

GENERAL NOTES SHEET 10: TEST STANDARDS, WIND SPEED CONVERSIONS, WIND LOADS - COMPONENTS & CLADDING,
ADJUSTMENT FACTOR FOR BUILDINGS HEIGHT & EXPOSURE, SHUTTER LEAF SIZES, FASTENER CALCULATIONS & LOCATIONS

COLONIAL SHUTTER SYSTEM and BAHAMA over COLONIAL SHUTTER SYSTEM		MICHAEL TRAPASSO PROFESSIONAL ENGINEER #62482	PRODUCT REVISED as complying with the Florida Building Code Acceptance No <u>16-0201-21</u> Expiration Date <u>11/28/2022</u> By <u>Hebert A. M...</u> Miami Dade Product Control	
Maximum Design Pressures Bahama & Colonial Shutter + 84.7 psf & - 113.3 psf Bahama Over Colonial Shutter + 77 psf & - 77 psf	 BRISCOE SHUTTERS INC. 2841 Shoreview Drive Naples FL 34112 www.bsisshutters.com Office: 239-774-2025 Fax: 239-774-9483	 1/19/16 3609 COTTAGE CLUB LANE NAPLES, FLORIDA 34105	DRAWING NO. 13-0579	SHEET NO. 10 of 10
Glass Separation Sheet 9			DATE: 01/18/16	
Patent No: US 6,996,934 B2 US 7,131,480 B2				

GENERAL NOTES:

- 1 THIS PRODUCT IS DESIGNED & TESTED IN ACCORDANCE WITH THE FLORIDA BUILDING CODE 5th EDITION (2014) BUILDING & RESIDENTIAL; FOR USE WITHIN AND OUTSIDE THE HIGH VELOCITY HURRICANE ZONE, TEST STANDARDS: TAS 201, 202, 203
- 2 THIS PRODUCT IS DESIGNED & TESTED IN ACCORDANCE WITH THE FLORIDA BUILDING CODE 5th EDITION (2014) BUILDING CHAPTER 16 - STRUCTURAL DESIGN & CHAPTER 24 - GLASS & GLAZING
- 3 THIS PRODUCT IS DESIGNED & TESTED IN ACCORDANCE WITH THE FLORIDA BUILDING CODE 5th EDITION (2014) RESIDENTIAL CHAPTER 44 HIGH-VELOCITY HURRICANE ZONES
- 4 ASCE 7-10, CHAPTER 30 (pg. 346) WIND LOADS - COMPONENTS AND CLADDING - METHOD 1, NET DESIGN WIND PRESSURES, Pnet 30 (psf) (Exposure B at h = 30 ft.) NOTE: FOR EFFECTIVE AREAS BETWEEN THE THOSE GIVEN ABOVE THE LOAD MAY BE INTERPOLATED, OTHERWISE USE THE LOAD ASSOCIATED WITH THE LOWEST EFFECTIVE AREA
- 5 ASCE 7-10, CHAPTER 30 (pg. 347), MINIMUM DESIGN LOADS - COMPONENTS IN CLADDING METHOD 1, ADJUSTMENT FACTOR FOR BUILDING HEIGHT AND EXPOSURE B, C, & D
- 6 FASTENER CALCULATIONS & LOCATIONS:
 $WIDTH \times HEIGHT \times DESIGN \ PRESSURE \ (6a) / FASTENER \ STRENGTH \ (6b) = TOTAL \ NUMBER \ OF \ FASTENERS \ REQUIRED \ PER \ OPENING \ (6c)$
 - 6a DESIGN PRESSURE REQUIRED BUILDING DATA: WIND VELOCITY (MPH), IMPORTANCE FACTOR, EXPOSURE CATEGORY, INTERNAL PRESSURE COEFFICIENT +, -, MEAN ROOF HEIGHT, BUILDING WIDTH, BUILDING LENGTH, & ROOF SLOPE (x/12)
 - 6b FASTENER STRENGTH, ALLOWABLE LOADS EQUAL TO 25% OF THE AVERAGE ULTIMATE LABORATORY TEST VALUES, ELCO CONSTRUCTION PRODUCTS AGGRE-GATOR FASTENERS 300 SERIES STAINLESS STEEL (HEX HEAD - 1/4 x 4 MAX.), CRETE-FLEX SS4 MASONRY SCREWS (HEX HEAD - 1/4 x 4 MAX.), ELCO ULTRACON CONCRETE & MASONRY ANCHORS (HEX HEAD - 1/4 x 6 MAX. OR HEX HEAD - 5/16 x 6 MAX.) OR FLORIDA FASTENERS DIRECT, LLC BLUE TAP SCREW ANCHORS - 1/4 DIAMETER HEX HEAD x 1-1/4" to 6" LONG OR EQUAL
 - 6c FASTENER SPACING AND LOCATIONS: MAJORITY OF FASTENERS AT PRESSURE POINTS (HINGES, HOLD CLOSE TABS OR BRACKETS) BALANCE ON SIDES (BAHAMA) OR TOP & BOTTOM (COLONIAL) OF THE BUILD OUT FRAME, IN ACCORDANCE WITH MANUFACTURES HURRICANE SHUTTER SHOP DRAWINGS FOR EACH SIZE AND / OR OPENING

 ANCHOR INSTALLATION SHALL BE MADE IN ACCORDANCE WITH ANCHOR MANUFACTURES PUBLISHED INSTALLATION INSTRUCTIONS AND THEIR APPROVED NOA
- 7 ANY COMBINATION OF WIDTH x HEIGHT NOT TO EXCEED 35.64 SQUARE FEET PER SHUTTER LEAF IS ALLOWABLE WITHIN THE DESIGN PRESSURE
- 8 BSI HURRICANE SHUTTER SYSTEMS HAS A BUILD OUT FRAME (BOF) (1) THAT ATTACHES TO THE BUILDING (INSIDE CLEAR OPENING IS 1/4" LARGER THEN BUILDING OPENING), DEPTH OF THE BOF IS GOVERNED BY THE GLASS SEPARATION, SHUTTERS ARE FACTORY ASSEMBLED TO THE BOF THEN DISASSEMBLED FOR SHIPPING & INSTALLATION
- 9 FOR THE PURPOSE OF THE TESTING REQUIRED IN TAS 202 SECTION 5.2, DESIGN PRESSURE CALCULATED IN ACCORDANCE WITH ASCE 7-10 ARE PERMITTED TO BE MULTIPLIED BY 0.6